

BONUS MODEL
Go-kart

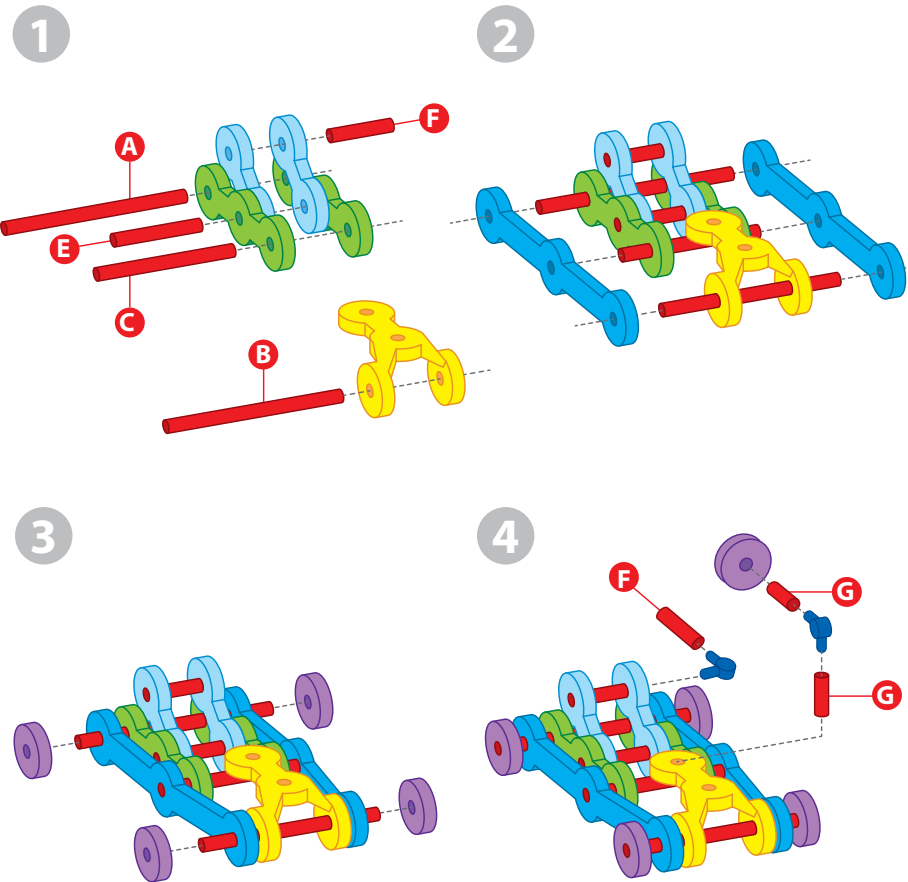

- x2
- x2
- x2
- x2
- x1
- x5
- x1
- x1
- x1
- x1
- x1
- x2
- x2

BONUS MODEL
Landsailer

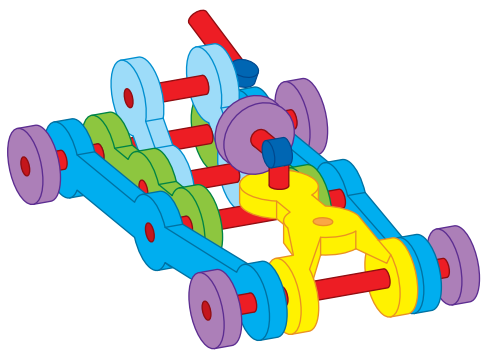
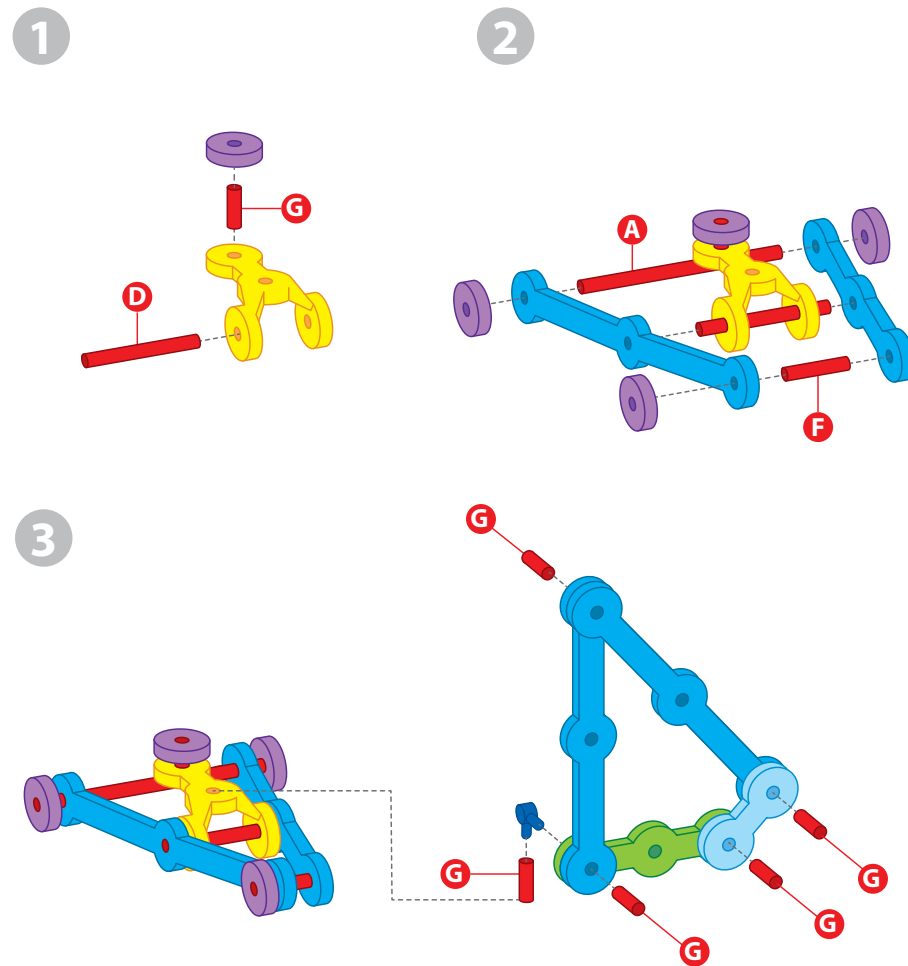
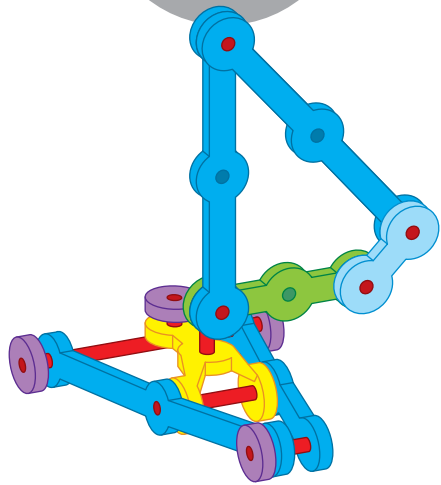

- x4
- x1
- x1
- x1
- x1
- x4
- x1
- x1
- x1
- x1
- x1
- x1
- x6

Creative Straw Kit - Vehicles

WARNING:
CHOKING HAZARD – Small parts.
Not for Children under 3 years.

Questions & Comments - We treasure you as a customer and your satisfaction with this product is important to us. In case you have any comments or questions, or you find any parts of this kit missing or defective, please do not hesitate to contact our distributor in your country, whose address is printed on the package. You are also welcome to contact our marketing support team at Email: infodesk@4M-IND.com, Fax (852) 25911566, Tel (852) 28936241, Web site: WWW.4M-IND.COM

A. Safety Messages

1. Please read through these instructions before you start.
2. Adult assistance and supervision are required.
3. Intended for children aged over 5.
4. This kit and its finished product contain small parts that may cause choking if misused. Keep away from children under 3 years old.

B. Contents

- x6
- x8
- x4
- x6
- x4
- x8
- x10
- x4
- x10

C. Instructions

- Study the assembly instructions and organise the parts before you begin building. The parts provided are used to build all of the first 4 models. You may then take them apart to construct the bonus models, which are considerably more complex. You can also design and make your own creations!
1. Follow the "Tube Cutting Guide" below to cut the tubes to length, according to the quantities required for this kit.
 2. Carefully clear away the holes from the foam parts.
 3. Take care not to damage the foam parts when inserting the tubes.
 4. The foam parts can bend to form new shapes.
 5. Squeeze the ends of the 2-pin connectors before inserting them into the tubes.
 6. Twist the tubes onto the 2-pin connectors.

Scan it! Watch it!



Watch the online instructional video!

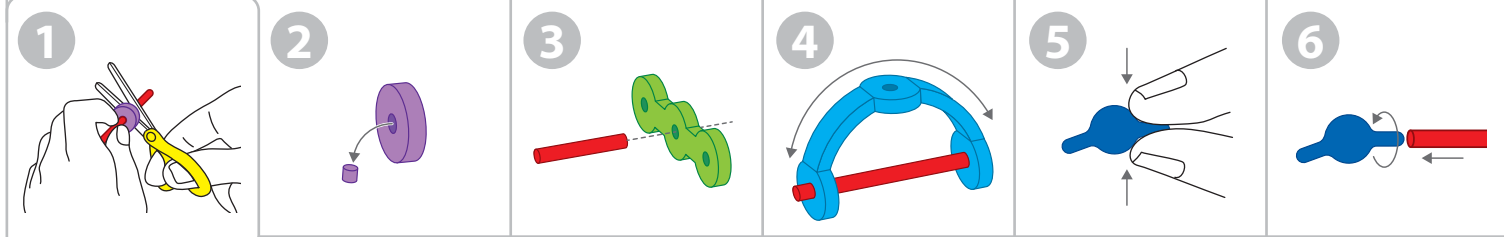

Tube Cutting Guide

IMPORTANT! Ask an adult to help cut the plastic tubes to size. Use the guide to cut the required number of tubes of each size. Cut the long lengths first and then cut the shorter lengths from the offcuts.

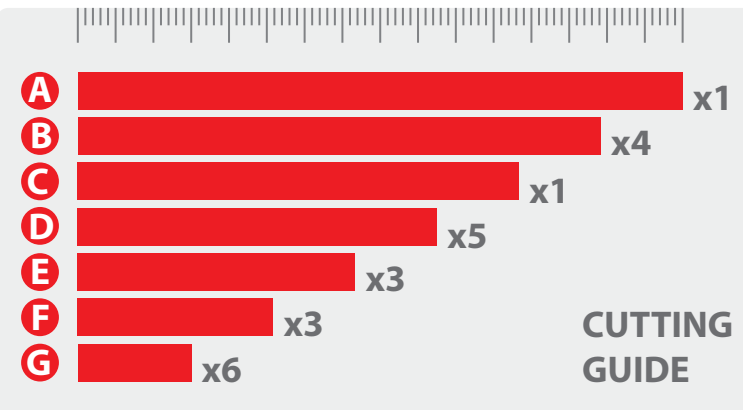

Use a foam disc as a guide to cut the tube.

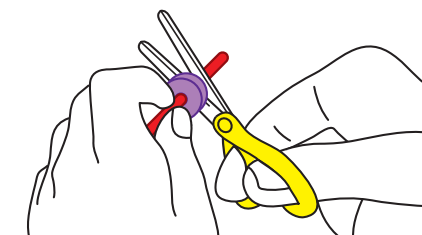
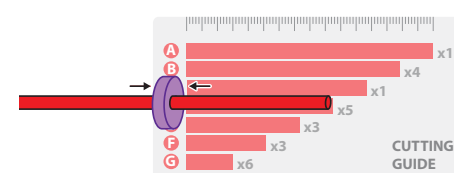

WARNING!

Cut the tubes straight.
Do not make a point.

Scooter

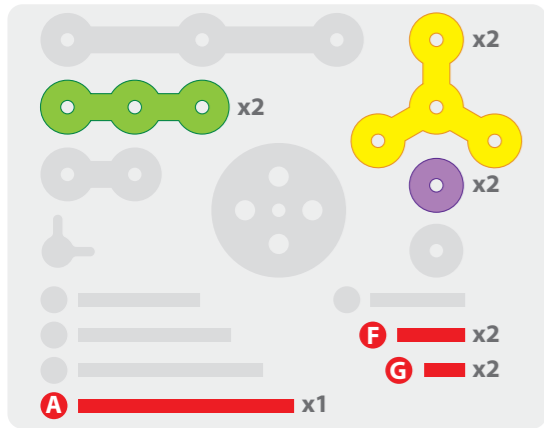
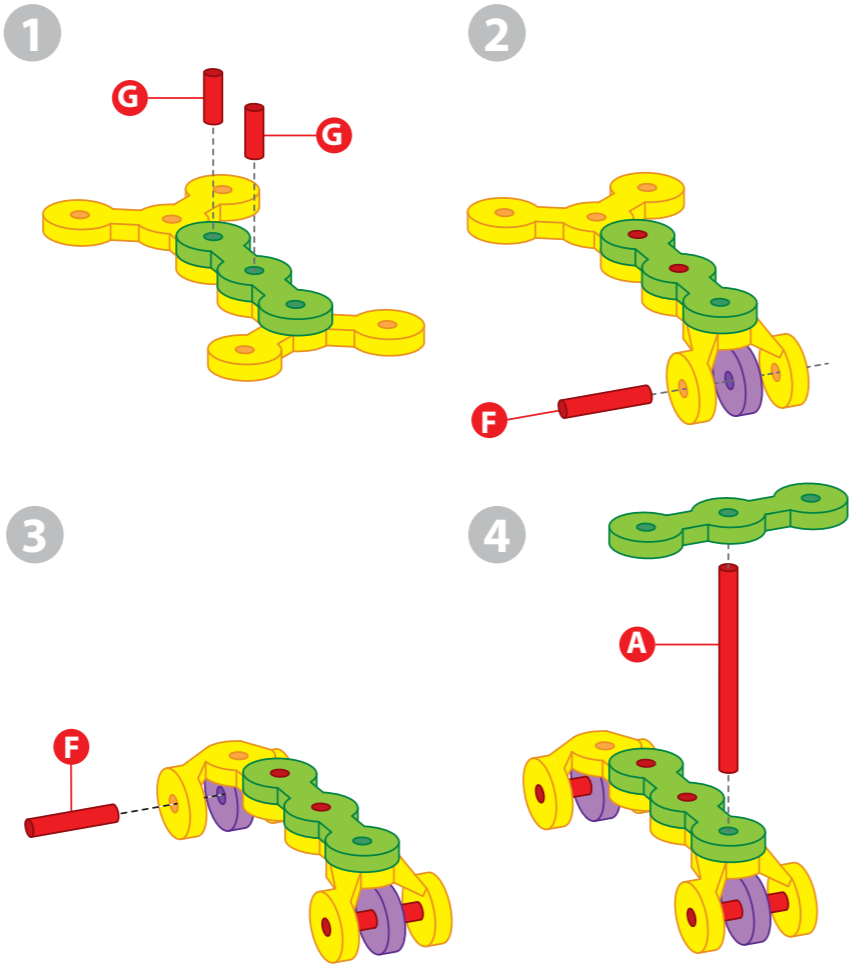
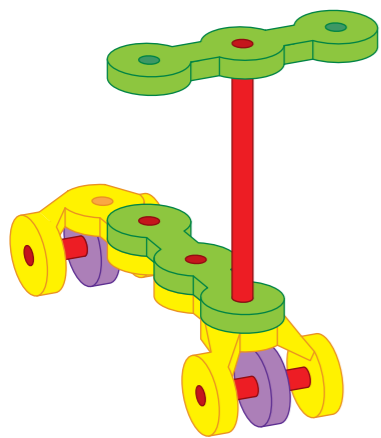

Car

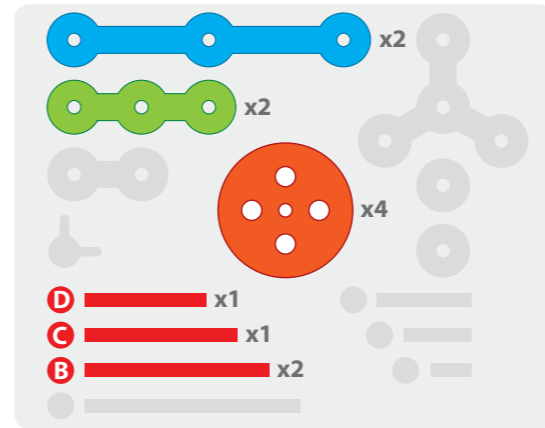
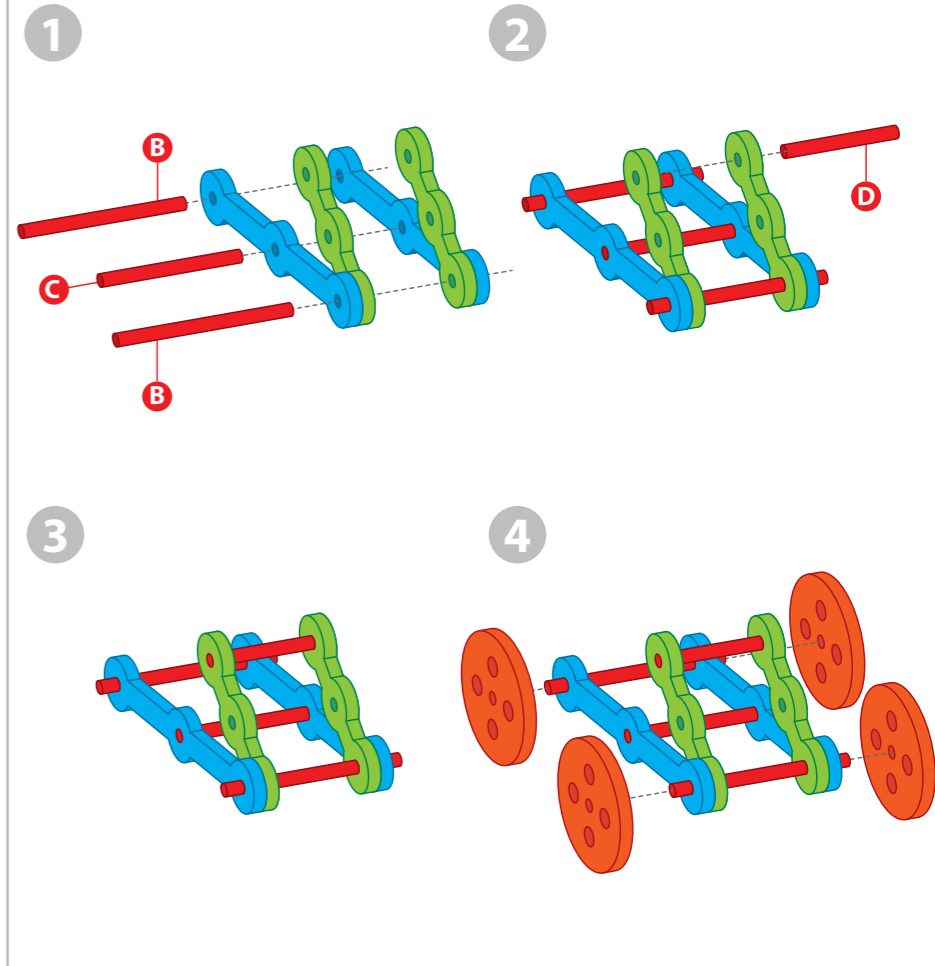
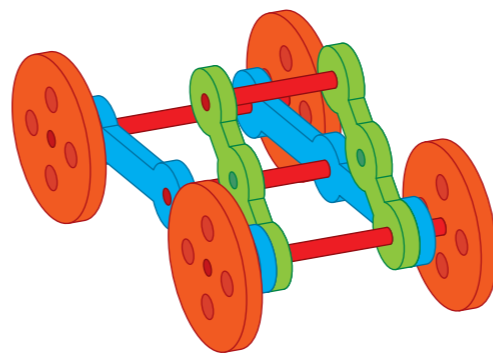

Tricycle

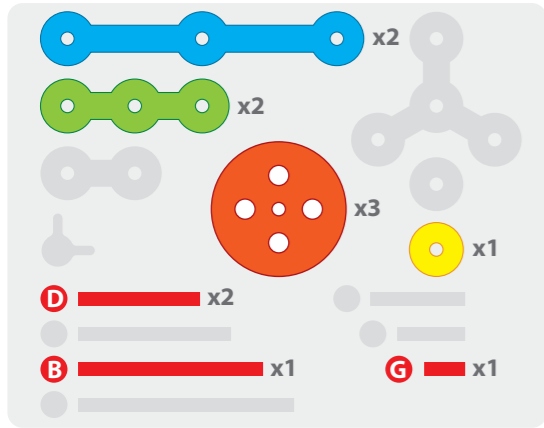
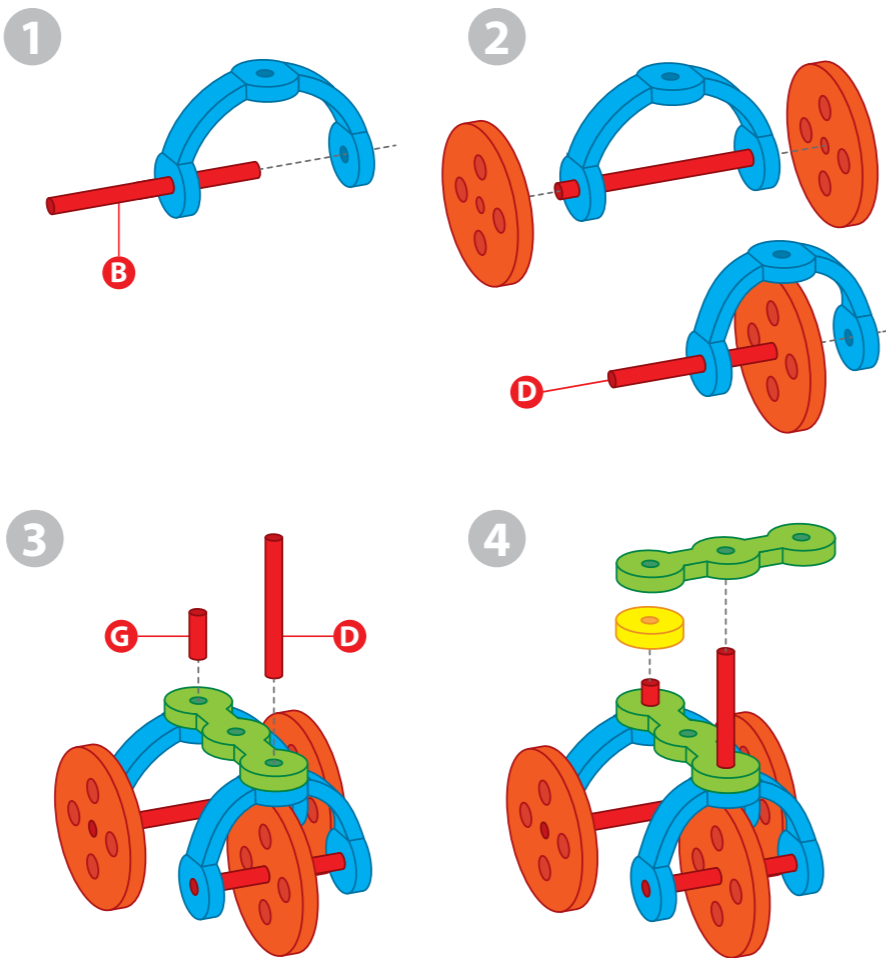
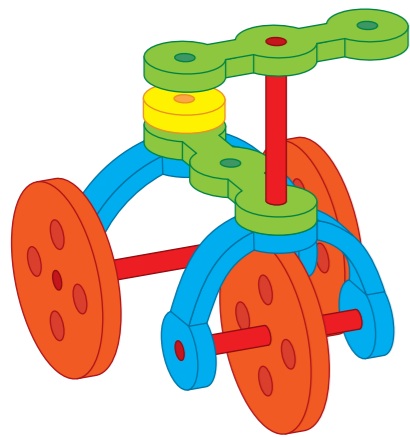

Dragster

